

# BASO 1.5 LOUVER DIRECT

## Catalog Number Example

BASO 1.5-SUR-WH-LBM-30K-C80-UNV-010V-SEN-0400LF-NLC-ST-24IN

### A RANGE

BASO 1.5      BASO 1.5

### B MOUNTING

Surface      SUR  
 Surface in-line ACT T-BAR      SAT  
 Surface in-line ACT SLOT      SAS  
 Surface ACT center tile      SAC  
 Pendant      PDT  
 Pendant in-line ACT T-BAR      PAT  
 Pendant in-line ACT SLOT      PAS  
 Pendant ACT center tile      PAC

pendant suspension set includes cable suspension and one white power feeder with a white junction box cover

for black power feeds or junction box covers, please contact customer service

### C COLOR

White      WH  
 Black      BL  
 Gray      GR  
 Custom color RAL      XX

trimless version available in white only

### D LENS

Louver black matte      LBM  
 Louver black gloss      LBG  
 Louver white matte      LWM  
 Louver white gloss      LWG  
 Louver chrome      LCH

### E CCT

3000K      30K  
 3500K      35K  
 4000K      40K  
 Custom CCT      XXX

### F CRI

CRI > 80      C80  
 CRI > 90      C90

### G VOLTAGE

120V / 277V      UNV

### H DIMMING

0-10V 1%      010V  
 Lutron EcoSystem      LES1  
 Quantum, Vive, GRAFIK Eye,  
 HomeWorks

Power over ethernet      POEC  
 consult customer service for compatibility  
 Custom dimming      XXXX  
 consult customer service for compatibility

### I SENSOR (optional)

Integrated Sensor      SEN  
 consult customer service for sensor request

### J OUTPUT LM/FT

400lm/ft 100% ±      0400LF  
 600lm/ft 100% ±      0600LF  
 800lm/ft 100% ±      0800LF  
 Custom lm/ft      XXXXLF  
 Custom output up to 800 lm/ft  
 see lumen output multiplier table on  
 page 2 for all lens colors outputs.  
 Multiplier for Direct Lens ONLY



### K CIRCUIT / EM

 Single circuit \*  
 EMC night light circuit      NLC  
 \* leave blank

### L SHAPE / PATTERN

Linear / straight      ST

### M DIMENSIONS IN INCH

Linear 2'      24IN  
 Linear 4'      48IN  
 Linear 6'      72IN  
 Linear 8'      96IN  
 Linear custom      ###IN

custom combinations including opal lens or wallwash optics available, please contact customer service with a drawing of your request

### N CERTIFICATION (optional)

Red List Approved      RLA

## PERFORMANCE

- Up to 118lm/W efficiency
- 400 / 400 / 800lm/ft
- CRI > 80 & CRI > 90
- IC & Damp rated
- UGR < 17

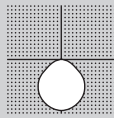

## MOUNTING

Recessed

Surface

Pendant

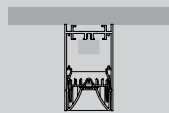
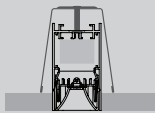

## MULTIPLE LENS COMBINATIONS

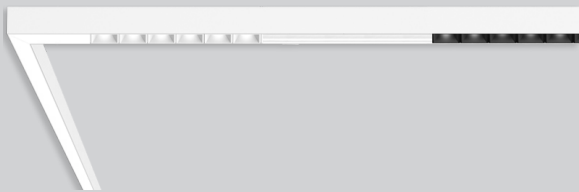

Contact customer service with a drawing of your request.

## INNOVATIONS



[link to page](#)

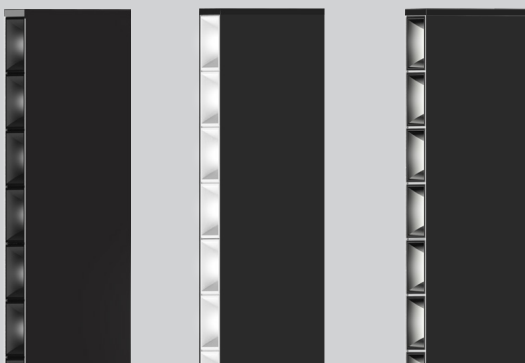

**Technical data**

	SIZE TYPE	LED COLOR TEMPERATURE	INPUT WATTS	DELIVERED LM TOTAL	LIGHT DISTRIBUTION	DELIVERED LM DIRECT	OPTICAL EFFICIENCY	LUMINAIRE EFFICACY
<b>BASO 1.5 LOUVER DIRECT</b>								
e LED	4' linear	30K, 35K, 40K	16.4W	1600lm	100% down	400lm/ft	67%	103lm/W
	8' linear		32.8W	3200lm				
e <sup>2</sup> LED	4' linear	30K, 35K, 40K	25.6W	2400lm	100% down	600lm/ft	67%	98lm/W
	8' linear		51.2W	4800lm				
e <sup>2+</sup> LED	4' linear	30K, 35K, 40K	35W	3200lm	100% down	800lm/ft	67%	92lm/W
	8' linear		70W	6400lm				

	LOR	LUMEN MULTIPLIER	DELIVERED LM/FT	DELIVERED LM/FT	DELIVERED LM/FT
<b>LOUVER LENS</b>					
LOUVER Matte White	67.3	1	400 lm/ft	600 lm/ft	800 lm/ft
LOUVER Glossy White	65.5	0.97	388 lm/ft	582 lm/ft	776 lm/ft
LOUVER Matte Black	49.4	0.73	293 lm/ft	439 lm/ft	585 lm/ft
LOUVER Glossy Black	49.1	0.73	293 lm/ft	439 lm/ft	582 lm/ft
LOUVER Chrome	65.4	0.97	388 lm/ft	582 lm/ft	776 lm/ft

*Multiplier for direct lens ONLY*

**Multiple lens combinations available**

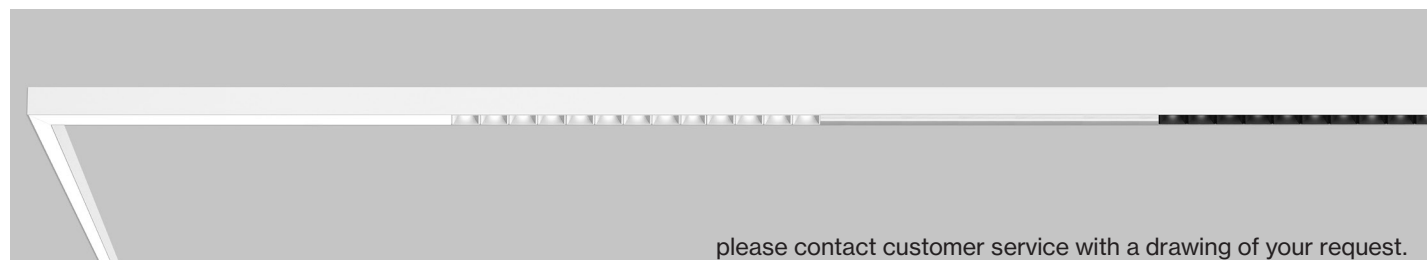

**Patterns top view**

**LINEAR**

A	FIXTURES	CODE
48"	1 × 4' linear	ST - 0 4 FT
96"	1 × 8' linear	ST - 0 8 FT
144"	3 × 4' linear	ST - 1 2 FT

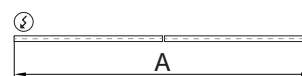

DIMENSIONS

**BASO 1.5 LOUVER**

SURFACE direct

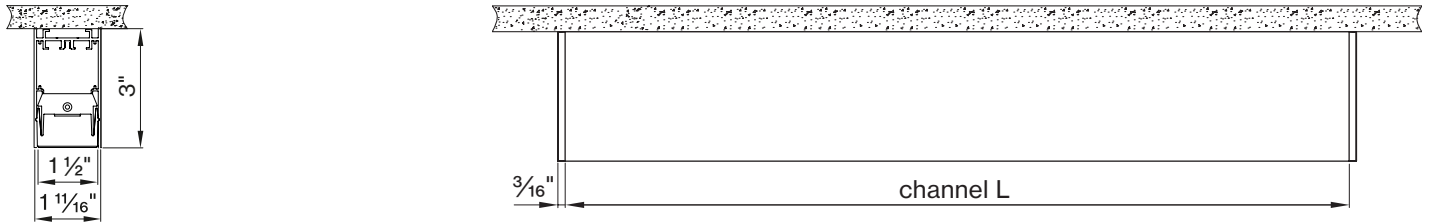

PENDANT

direct

direct / indirect

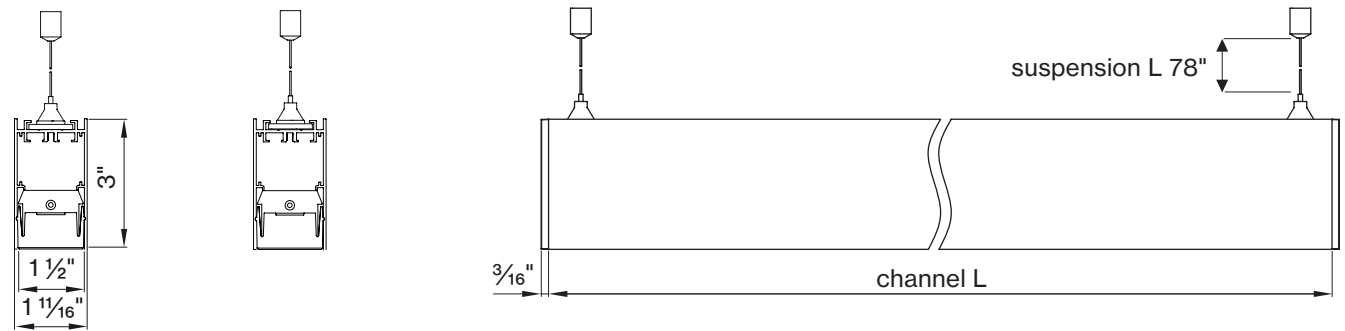

**BASO 1.5 Louver SPECIALITY MOUNTING**

SURFACE in-line ACT TBAR

SURFACE in-line ACT SLOT

SURFACE ACT center tile

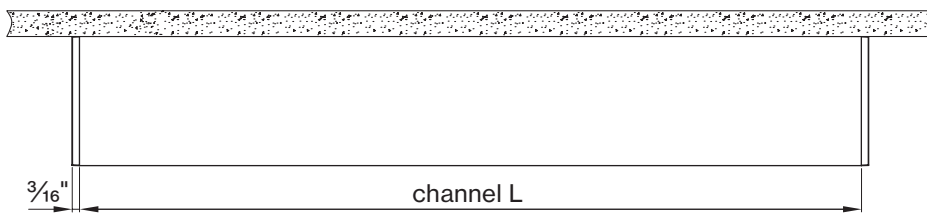
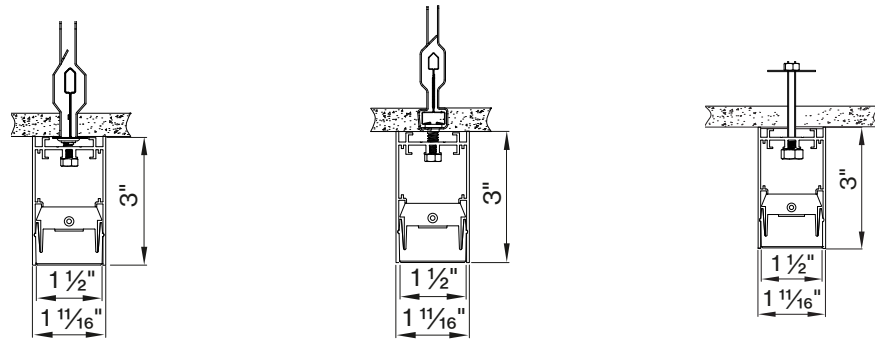

**BASO 1.5 Louver SPECIALITY MOUNTING**

PENDANT ACT TBAR

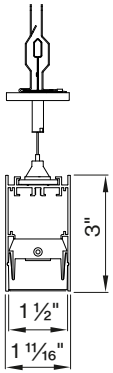

PENDANT in-line ACT SLOT

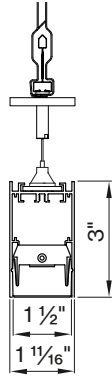

PENDANT ACT center tile

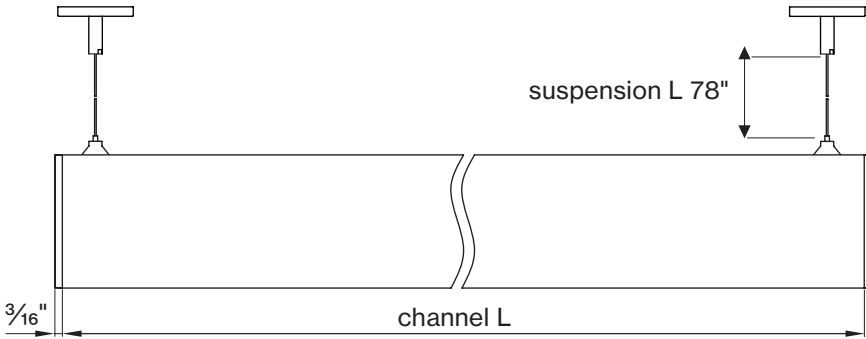
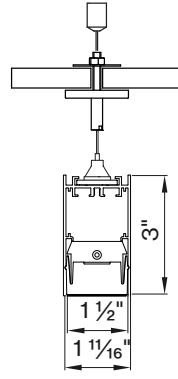

**Declare.**

**BASO 1.5 2.5 4.0**  
**XAL USA Incorporated**  
 Final Assembly: Oxford, Connecticut, USA  
 Life Expectancy: 3 Years  
 End of Life Options: Recyclable (70%), Landfill (30%)

**Ingredients:**  
 Acrylamide, 2-Propanol, acryl, 2-methyl-, methyl ester, polymer with ethyl 2-propanoate, steel manufacturing chemicals, Copper chloride (CuCl<sub>2</sub>), Polyvinyl Alcohol (Alcohol Substrate), Poly(ethylene Glycol) (E-Glycol), hexamethylenetetramine (G-hexamethyl), Copper ions (In Organic Solvent, etc.)

ULC Temp Exception RL-002 - Small Electrical Components

**Living Building Challenge Criteria:**

**ULC Red List:**  
 - ULC Red List Free % Disclosed: 100% at 50ppm  
 - ULC Red List Approved VOC Content: Not Applicable  
 - Incorporated

**ULC Interior Performance:** Not Applicable  
**ULC Responsible Sourcing:** Not Applicable

XAL-0002  
 QSR 01-MAR-2024  
 Original Issue Date: 2023

INTERNATIONAL LIVING FUTURE INSTITUTE™ [www.livingfutureinstitute.com](http://www.livingfutureinstitute.com)

**BASO mounting instructions**

Get access to the BASO 1.5 LOUVER mounting instructions faster by scanning the QR code.



[www.xalusa.com/resources/mounting-instructions/baso](http://www.xalusa.com/resources/mounting-instructions/baso)